

FOR NATURAL GAS USE ONLY

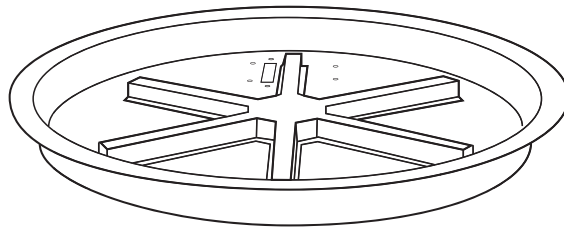

Golden Blount



**Outdoor Match Light
Continuous Spark Fire Pit Components**
Installation and Operating Instructions

IF YOU CANNOT READ OR UNDERSTAND THESE INSTALLATION INSTRUCTIONS DO NOT ATTEMPT TO INSTALL OR OPERATE THIS APPLIANCE

INSTALLATION PRECAUTION:

This fire pit requires a minimum 18-square inches (per side) of cross ventilation. Failure to provide proper ventilation can void the warranty.



Warning: For Outdoor Use Only

PLEASE RETAIN THIS MANUAL FOR FUTURE REFERENCE



DANGER



CARBON MONOXIDE HAZZARD

This appliance can produce carbon monoxide which has no odor.

Using it in an enclosed space can kill you.

Never use this appliance in an enclosed space such as a camper, tent, car or home.



DANGER

If you smell gas:

1. Shut off gas to the appliance.
2. Extinguish any open flame.
3. If odor continues, keep away from the appliance and immediately call your gas supplier or fire department.



WARNING

Do not store or use gasoline or other flammable vapors and liquids in the vicinity of this or other appliance.

WARNING

Do not leave unattended during use.
Do not use for cooking.
Follow all gas leak procedures in this manual prior to operation.



WARNING

Improper installation, adjustment, alteration, service or maintenance can cause injury or property damage. Read the installation, operating and maintenance instructions thoroughly before installing or servicing this equipment



WARNING: If this fire pit is exposed to rain,snow,ice or water it must be fully dried out before next operation.

WARNING: If the information in these instructions is not followed exactly, a fire or explosion may result causing property damage, personal injury or death.

FOR YOUR SAFETY

Do no store or use gasoline or other flammable vapors and liquids in the vicinity of this or another appliance.

SPECIFICATIONS

Model	A Pan Depth	B Min./Max Install Opening	C Inside Pan	D Ground Level
GFP-24-PAN-CSI	2.5"	24.5"/29"	24"	8"
GFP-36-PAN-CSI	4	36.5"/41"	36"	8"

Table1. Fire Pit Dimensions

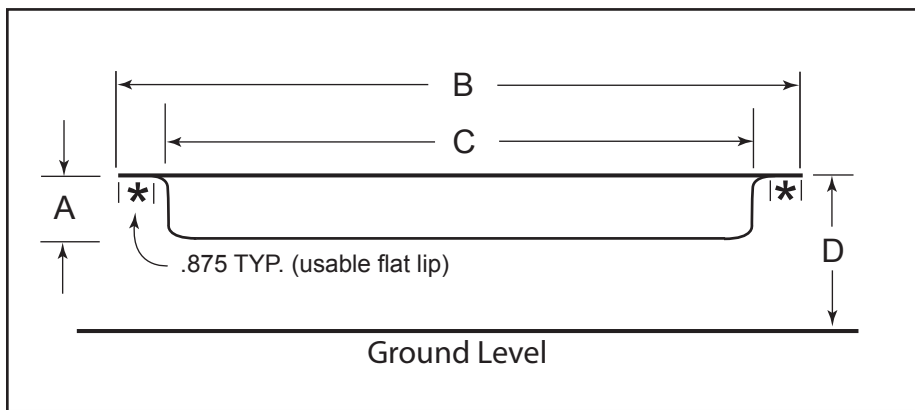

Figure 1. Fire Pit dimensions; refer to Table 1.

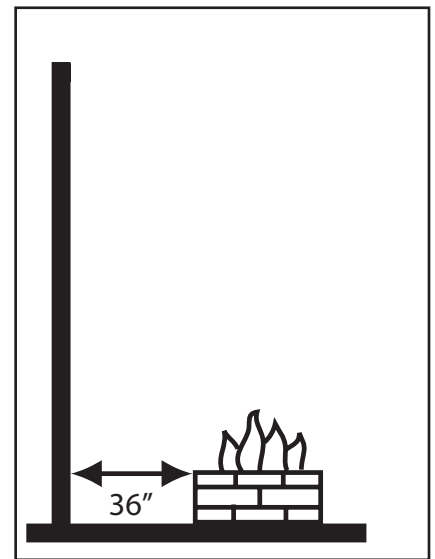

Figure 2. Clearance to Combustibles
(Not to be used in an enclosed space)

Model	<i>Btu's Natural Gas</i>
SPOKE-14	80,000 Btu's
SPOKE-+20	160,000 Btu's

Table 2. Btu Specifications

	NG
Min.. Inlet	5.0"WC
Max. Inlet	10.5"WC

Table 3. Gas Pressures

Note: Fire pits are rated at maximum Btu's which is dependent upon proper gas pipe sizing. Flex line size also affects Btu's. As a result your Btu's may vary from Table 2 specifications listed above.

PLEASE NOTE:

If you purchased a spoke burner only without the fire pit pan, the burner must still be installed into a non-combustible structure following the same requirements throughout this installation manual.

WARNING: Proper clearances from combustible, construction and materials must be maintained from all sides, top and bottom of this appliance. This appliance should never be placed on any combustible surface. This appliance should never be placed closer than 36-inches from any side to any combustible construction or materials.

PREPARING A NON-COMBUSTIBLE STRUCTURE

The Fire Pan is to be installed on a flat, stable surface, away from any combustible materials. Install Fire Pit on any level, outdoor non-combustible surface. NOTE: Do not place fire pan directly on grass, dirt, or rocks this may prevent proper ventilation.

HARD PIPING TO FIRE PIT WITHOUT GAS PROXIMITY

NOTE: We recommend using 1/2" or 3/4" black iron pipe however please refer to the NFPA54 (National Fuel Gas Code) for proper pipe sizing when exceeding 20-feet in length for fire pits rated above 100,000 Btu's

1. Turn **OFF** gas supply system. **NOTE:** All gas connections (except for brass to brass) require the following. Clean pipe threads using either a wire brush or steel wool. Apply Teflon tape or pipe sealant to the steel fittings before making any connection. **BE CAREFUL!** Ensure all gas connections are snug, but not over tighten!
2. Extend the gas supply system using minimum of 1/2" black iron pipe or an approved flexible gas line from existing house supply. This can be accomplished by teeing off or tapping into a convenient gas line connection. Install necessary pipe for the distance required and then install a manual shut-off valve at the exterior house wall. If pipe is to pass through a foundation or house wall, make sure to re-seal the area around the pipe with weather sealant.
3. From manual valve, extend gas pipe to the Fire Pit location. **NOTE:** If pipe is to be placed in an underground trench, check with local codes for required depth and materials needed.
4. Install a 3/4" female x 1/2" male flared brass fitting to the end of the 3/4" black iron pipe. Be sure to clean the pipe threads and use Teflon tape or pipe sealant.
5. Connect the 1/2" female flared flex connector from the Fire Pit to the 1/2" male flared brass fitting secured to the black iron pipe. **Note:** Flare to flare connections do not require Teflon tape or pipe sealant.

IMPORTANT

Installation of Natural gas should be done by a qualified installer, service agency or gas supplier.

The appliance and its manual shutoff valve must be disconnected from the gas supply piping system during any pressure testing of the system at test pressures in excess of 1/2 psig (3.5kPa). This appliance must be isolated from the gas supply piping system by closing its manual shutoff valve during any pressure testing of the gas supply piping system at test pressures equal to or less than 1/2 psig (3.5kPa)

VENTILATION FOR NON-COMBUSTIBLE ENCLOSURE

Fire pits are subjected to many outdoor elements such as rain, snow, wind, heat or cold. **A minimum of 18 square inches of cross ventilation (2 sides) is required to keep the components in good working order.** Use figure 3 as guide to assist to incorporate proper ventilation. **NOTE:** Ventilation is not required at the bottom and may also be incorporated in the upper portion of an enclosure.

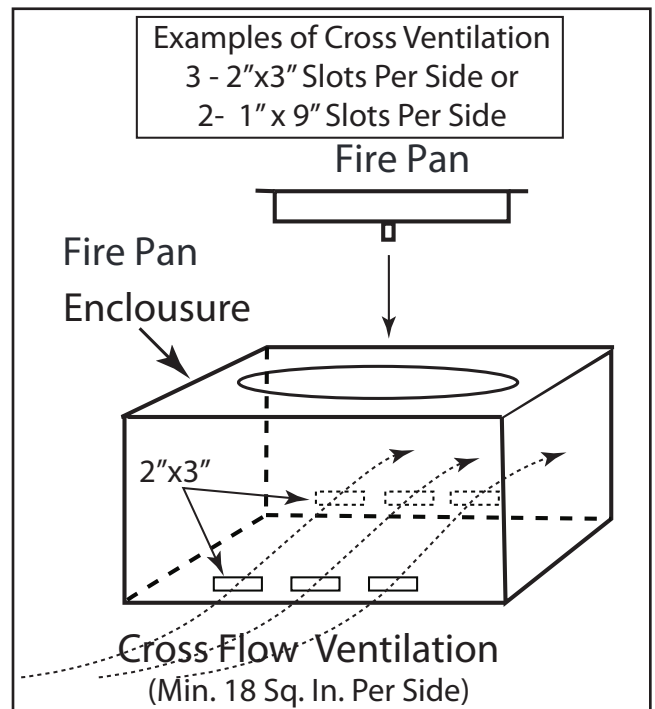

Figure 3. Cross Ventilation Example

INSTALLATION OF FIRE PAN INTO AN APPROVED ENCLOSURE

REQUIREMENTS

1. Only non-combustible materials should come in direct contact with any part of the Fire Pan. Underneath area should be non-combustible as well.
2. Only use 3/4" gas supply line to the Fire Pan. Based on the selection of the fire pan size, the proper brass fittings should be used to ensure a proper installation.
3. Determine the size of the round or square Fire Pit you are preparing to install (Refer to page 4).
4. You must provide a round or square opening out to place the fire pan into the non-combustible enclosure surround. Do not exceed the maximum opening from Table 1, dimension B.
5. Follow the local code requirements for the gas type being used. This Fire Pan should be installed in accordance with local codes and ordinances or in the absence of local codes, with the latest National Fuel Gas Code, ANSI Z223.1 NFPA54.
6. Fire Pits create high temperatures, it is very important to have any combustibles at a safe distance.
7. **CAUTION: A minimum of 18 square inches of cross ventilation (per side) is required to keep the enclosure dry.**
8. These products are designed for outdoor use only. Not approved for any indoor use.
9. This Fire Pan is designed to have Lava Rock/Media completely covering the spoke burner, so that the burner is invisible. Do not cover more than 2" above the top of the covered burner. When purchasing Lava Rock it is recommended to use minimum of 1" diameter as a base to fill the burner pan. Decorative glass covering may be loosely scattered on top of the rock if desired or non-combustible logs may be added for a campfire look. If logs are chosen, do not place on decorative glass base, use only Lava Rock as the base.
10. Gas lines and fittings must be installed in to the non-combustible structure. All gas connections must be leak tested before installation of the fire pit. Soapy water leak detection is required before regular use of the fire pit.
11. Do not use material that will absorb moisture over time and will not release this moisture quickly. Moisture can boil in this material and can rapidly break apart and cause damage or personal injury.
12. Never leave any other combustible material on top of the fire pan. This could cause unsafe operation of this system and damage to the component that will not be covered under our warranty.
13. Cover the complete burner with lava or decorative Rock material (min. 1-inch diameter). Completely cover the spoke burner, no more than 2-inches above the spoke burner.

INSTALLING KEY VALVE AND PIEZO IGNITOR

A separately purchased key valve, 1- key valve, 1- key and 1- flange. (See figure 4). The valve requires a 1 1/4" round clearance hole in the non-combustible enclosure wall. See the instructions supplied with the key valve for more specific details. Note: Be sure to leak test all fitting before operation. Figure 5 shows an example of a typical installation.

After the fire pit pan is installed run the piezo igniter wires into the electrical junction box. Piezio wires are 24-inches in length, ensure your installation does not exceed the wire length for proper connection.

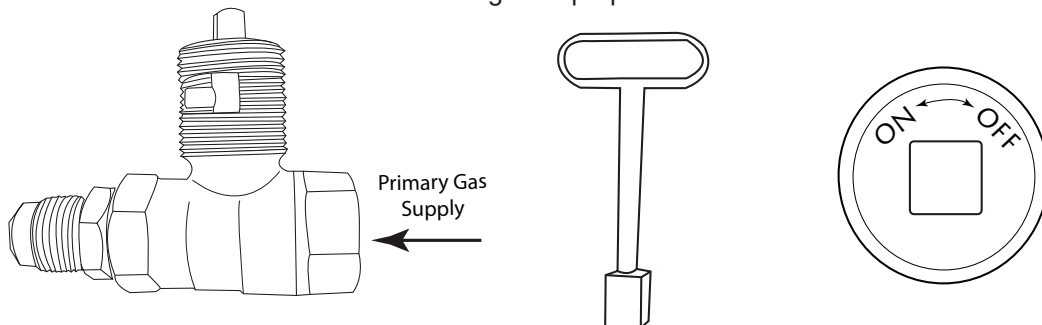
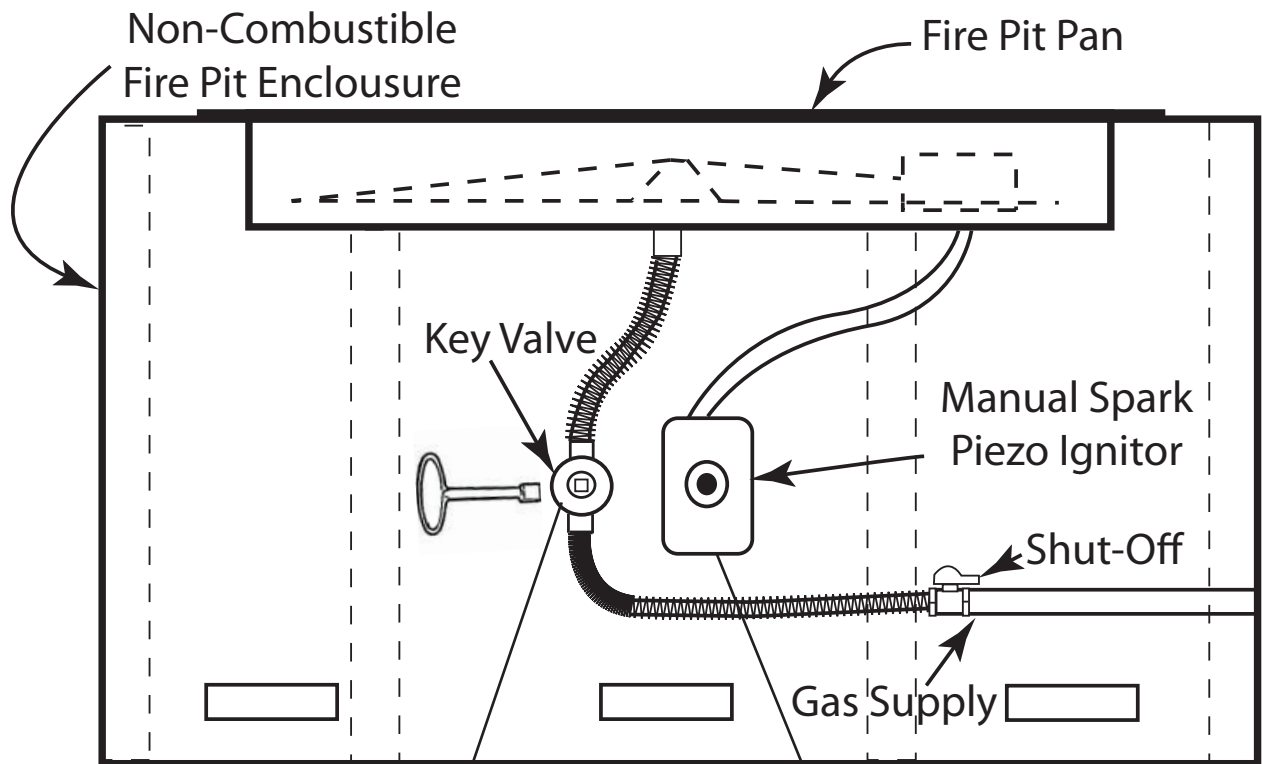
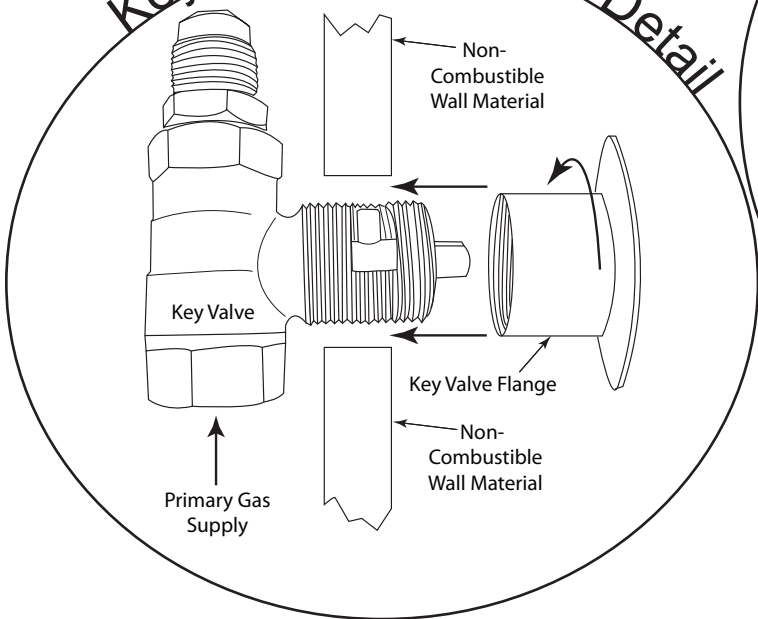

Fig. 4 Key valve components.



NOTE: Gas supply shut-off and flex line to the key valve are not supplied.

Key Valve Side View Detail



Piezo Ignitor Side View Detail

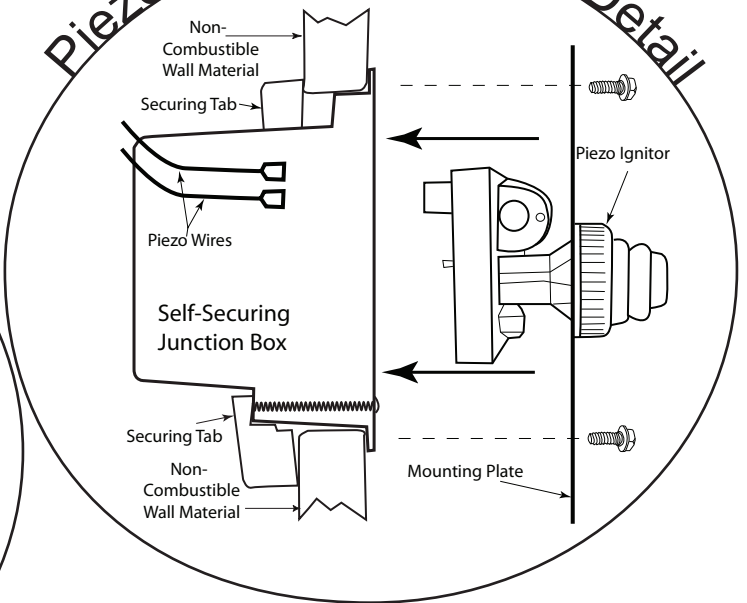
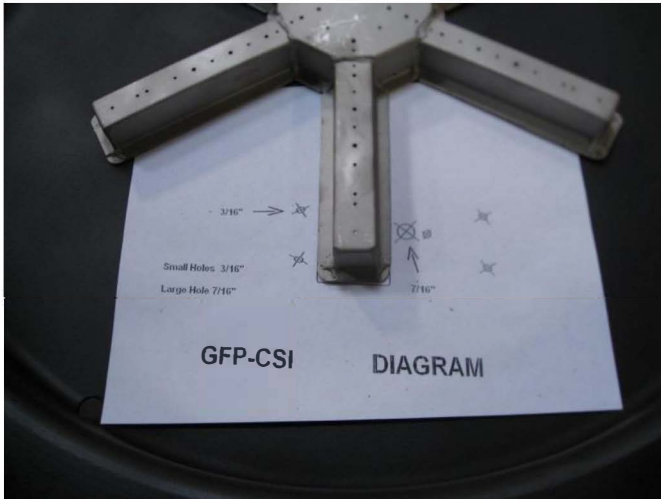

Fig. 5 Typical installation.

GFP-CSI INSTALLATION INSTRUCTIONS



Step 1

Place diagram between burner and pan.

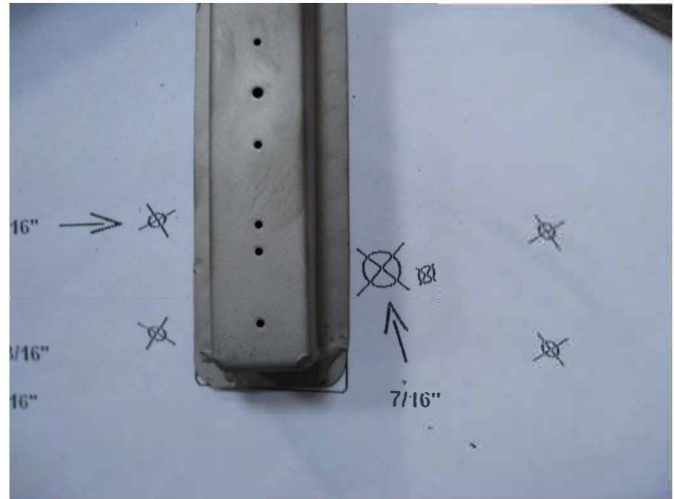

Step 2

Align burner leg with diagram and mark holes.



Step 3

Drill holes with proper drill bit size as listed on diagram.



Step 4

Insert spark igniter and add screw.

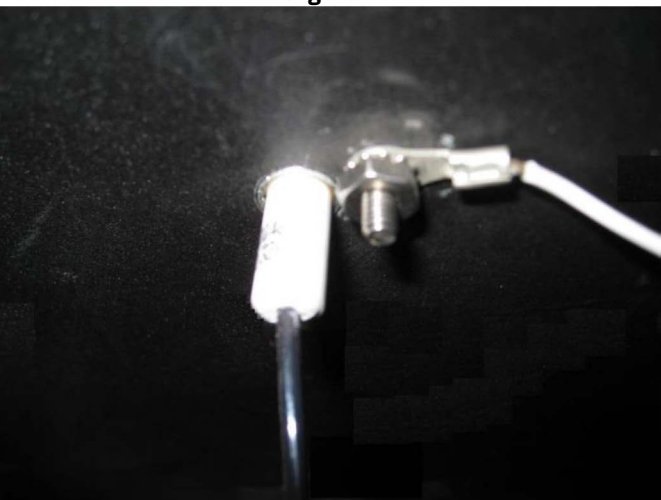

Step 5

Attach ground wire and nut.

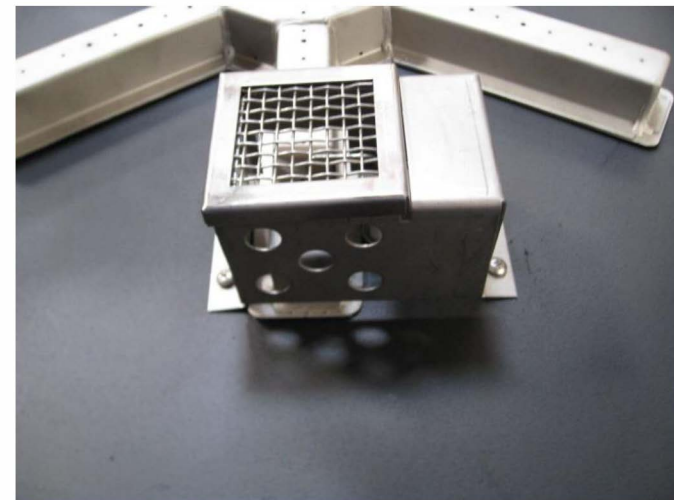

Step 6

Cover with housing and attach leads to igniter.

INSTALLATION OF BATTERY INTO PIEZO IGNITOR (Continuous Spark Ignition)

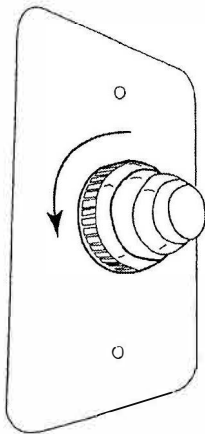

Fig. 6 Piezo ignitor cap.

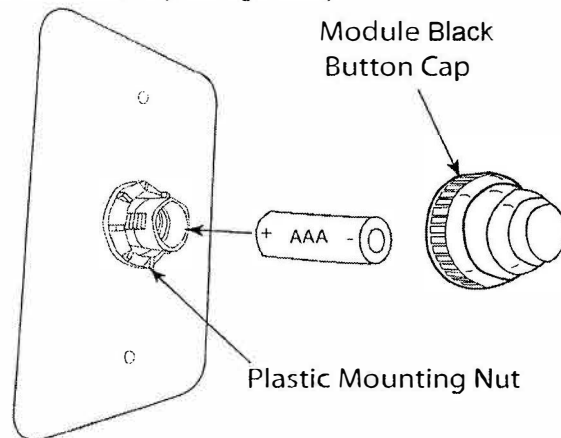

Fig. 7 Piezo ignitor battery installation.

The piezo ignitor requires (1) AAA battery in order to spark/operate. Unscrew (counter-clockwise) the piezo ignitor cap (See fig. 6) and insert the positive end of the battery into the ignitor body. Screw the cap (clockwise) until snug (See fig. 7). Careful not to overtighten the cap. Test the ignitor by pushing and holding the red button to ensure the ignitor probes inside the fire pit are sparking. The spark should be located directly overtop of the burner port hole for proper ignition of the gas (See fig.8). Spacing between the probe and spoke burner should be approximately $3/16$ -inch for proper spark.

IGNITOR ALIGNMENT (Manual Spark Ignition only)

For proper ignition it is important that the ignitor probe be properly aligned overtop of the burner port holes. Use Fig.8 as a guide. Before lighting remove the screen cover of the ignition hood to burner and ensure the spark probe is directly overtop of a burner port hole. The sparking probe must be in the path of a flame to ignite the gas for proper ignition of the flame. Replace the screen cover and follow the operating instructions.

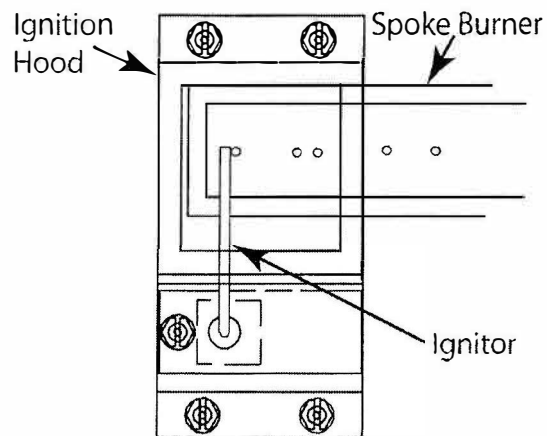

Fig. 8 Proper alignment of probe.

INSTALLATION OF LAVA ROCK/MEDIA INTO BURNER PAN

Install lava rock/media into the burner pan. Ensure the media is a minimum of 1-inch diameter for proper operation. **Note:** Do not pour Lava Rock directly from bag. Media should be placed naturally and NOT packed in tight. Loose fitting is important to ensure robust flames. Be sure rocks are free of any excessive dust. This prevents the burner pan weep holes from being plugged and holding water. **IMPORTANT:** Do not place media over top or under the screen cover. The screen must be free of any debris to ensure proper lighting of burner and good flame rectification.

Cover the burner completely with media but do not make the depth greater than 2-inch overtop of the burner portholes.

Decorative glass may be loosely scattered on top of the lava rock. Do NOT cover the stainless steel screen cover with any rock or glass. It must be free an any debris to operate properly.

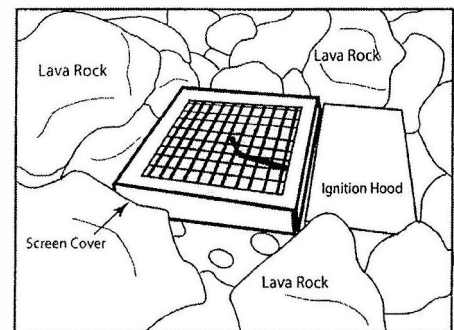

Fig. 9 Keep screen cover exposed

OPERATION

CAUTION: Children and adults should be alerted to the hazards on high surface temperatures and should stay away to avoid burns or clothing ignition. Young children should be carefully supervised when they are in the area of the firepit .

WARNING: Do not use this fire pit if any part has been under water. Immediately call a qualified service technician to inspect the fire pit and to replace any part which has been under water.

SAFETY WARNINGS

1. Never leave the Fire Pit unattended during operation.
2. Clothing or other flammable materials should not be placed on or near the fire pit.
3. Any guard or other protective device removed for servicing the fire pit must be replaced prior to operating .
4. Installation and repair should be done by a qualified service person. The components should be inspected before use and at least annually by a qualified service person. More frequent cleaning may be required as necessary. It is imperative the burners and circulating air passageways of the fire pit housing be kept clean.
5. Inspect the fuel supply connection before each use of the fire pit.

WARNING

1. This product is hot when operated and can cause sever burns if contacted.
2. Do not burn any solid fuels in fire pit pan.

MANUAL SPARK IGNITION LIGHTING INSTRUCTIONS

READ ALL LIGHTING INSTRUCTIONS BEFORE ATTEMPTING TO LIGHT FIRE PIT

CAUTION: Ensure you have leak tested the fire pit before operating.

1. Insert key into gas valve.
2. Push and hold the button on the manual Piezo ignitor and ensure sparking is occurring at the probes inside the fire pit.
3. Rotate the key counter-clockwise in gas valve to allow gas to flow.
4. Gas should ignite within 10 seconds or less. If fire pit does not light within 10 seconds turn key clockwise to turn OFF the gas supply. Check ignitor probe location (Fig. 8), ensure there is an 1/8" gap between the probes with a good stong spark then repeat steps 2 through 4.

MATCH THROW LIGHTING INSTRUCTIONS

READ ALL LIGHTING INSTRUCTIONS BEFORE ATTEMPTING TO LIGHT THE FIRE PIT

CAUTION: Ensure you have leak tested the fire pit before operating.

1. Insert key into gas valve.
2. Light a long match or butane lighter and hold it near the burner.
3. Rotate the key counter-clockwise in gas valve to allow gas to flow and simultaneously apply the burning match as close to burner as possible to light the fire pit.
4. Gas should ignite within 10 seconds or less. If fire pit does not light within 10 seconds turn key clockwise to turn OFF the gas supply. Ensure there is not too much media on top of spoke that my inhibit gas flow and try again.

FIRE PIT MAINTENANCE

1. The Fire Pit should be inspected and cleaned before initial use at least annually by a qualified field service person.
2. Any component that is found faulty must be replaced with an approved component.
3. Any tampering or modifying with the Fire Pit is dangerous and voids all warranties.
4. During winter months in cold climates and various seasons operation the Fire Pit may be affected by weather conditions. Heavy rains/downpours could affect the Fire Pit operation. If this occurs ensure you allow the Fire Pit time to dry out before attempting to operate. NOTE: If a combustible type cover is used over the Fire Pit when not in use be sure to remove it before operation to prevent a severe safety hazard.
5. Carbon (soot) may build up on the surface of logs (if installed) during heavy use. Sooting may also occur periodically on the screen of the ignitor hood. To clean, brush off with a dry bristle brush or cloth. Keep soot away from clothing or furniture.
6. Over time stainless steel parts discolor when heated, usually a golden or brown hue. This discoloration is normal and does not affect the performance of the appliance.

TROUBLE SHOOTING

<u>Sympton</u>	<u>Remedy</u>
Piezo won't spark	<ol style="list-style-type: none">1. Be sure battery is installed properly.2. Check battery voltage. Min.. 1.2 VDC needed.3. Check ignitor gap at probes inside fire pit. Gap should be at 1/8".4. Double check wires to ensure they are installed and secure.
Fire pit won't light	<ol style="list-style-type: none">1. Ensure ignitor is aligned properly ovetop of burner port hole.2. Bleed gas line.3. Ensure all gas supply lines are turned ON.4. Ensure there is not too much media ovetop of burner; it can inhibit gas from flowing.
Low Flame	<ol style="list-style-type: none">1. Ensure all shut-off valves and key valve is fully open.
Water in my Fire Pit	<ol style="list-style-type: none">1. Excess dust/sand material from media is blocking the weep holes to relieve water. Remove all media and unplug weep holes. Clean or install new media free of dust and dirt.

RESIDENTIAL WARRANTY

GOLDEN BLOUNT FIRE PIT COMPONENTS ARE WARRANTED AS FOLLOWS

FIRE PIT PANS / STANDS - (2)Two years against rust or corrosion where pans rust or corrode completly.

FIRE PIT BURNERS - (5) FIVE years against deterioration due to rust or corrosion. Note: Discoloration is normal on all stainless burners.

CSI IGNITION KIT - (1) One year, no warrenty on battery.

CERAMIC LOGS - (2) Two years against deterioration. Note: Small cracks are a normal condition.

This warranty does not cover claims, which do not involve defective workmanship or materials. Damage to fire pits caused by accident, misuse, abuse, or installation error, whether performed by a contractor, Service Company, or owner, is not covered by this warranty. Modification of this product will void this warrenty.

IN NO EVENT SHALL Golden Blount, INC. BE LIABLE FOR INCIDENTAL AND CONSEQUENTIAL DAMAGED. THIS WARRANTY SUPERSEDES ALL OTHER ORAL OR WRITTEN WARRANTIES.

GOLDEN BLOUNT, INC.
FACTORY AND CORPORATE OFFICES
4301 WESTGROVE DR., ADDISON, TX 75001 972-250-3113 FAX 972-250-3016
www.goldenblountinc.com